

Pointlock

фирменный стиль

Искажение товарного знака, фирменного цвета, пренебрежение модульным построением логотипа и блоков ведут к разрушению единого стиля, наносят ущерб престижу и имиджу компании

Данный фирменный стиль является
интеллектуальной собственностью
ООО «ТОП-ЛОК»

Логотип построение	3
Логотип для белого фона	14
Логотип для темно-серого фона	16
Логотип монохромный	18
Логотип в один / два цвета	19
Логотип контур	20
Сервисные иконки / элемент оформления шестеренка	21
Логотип Сервисный центр	22
Шрифты	23
Типографика / композиция рекл. элементов	24
Анонс-принты	26
Имидж-принт	27
Панель-кронштейн	28
Пилон	30
Штендер	32
Вывеска	33
Фриз/ кант	34
Режим работы	35
Форма объявления / анонса / бейдж	36
Бланк / Шаблон презентации для PowerPoint	37
Визитка личная / корпоратив. / сервис	43
Футболка сервис	44
Бейсболка сервис	45
Сувенирка (бейсболка, футболка, ручка условная)	46
Сертификат	47
Рекламный модуль	49
Экстерьер магазина (пример)	50
Интерьер магазина (пример)	51
Маркировка автомобиля	53

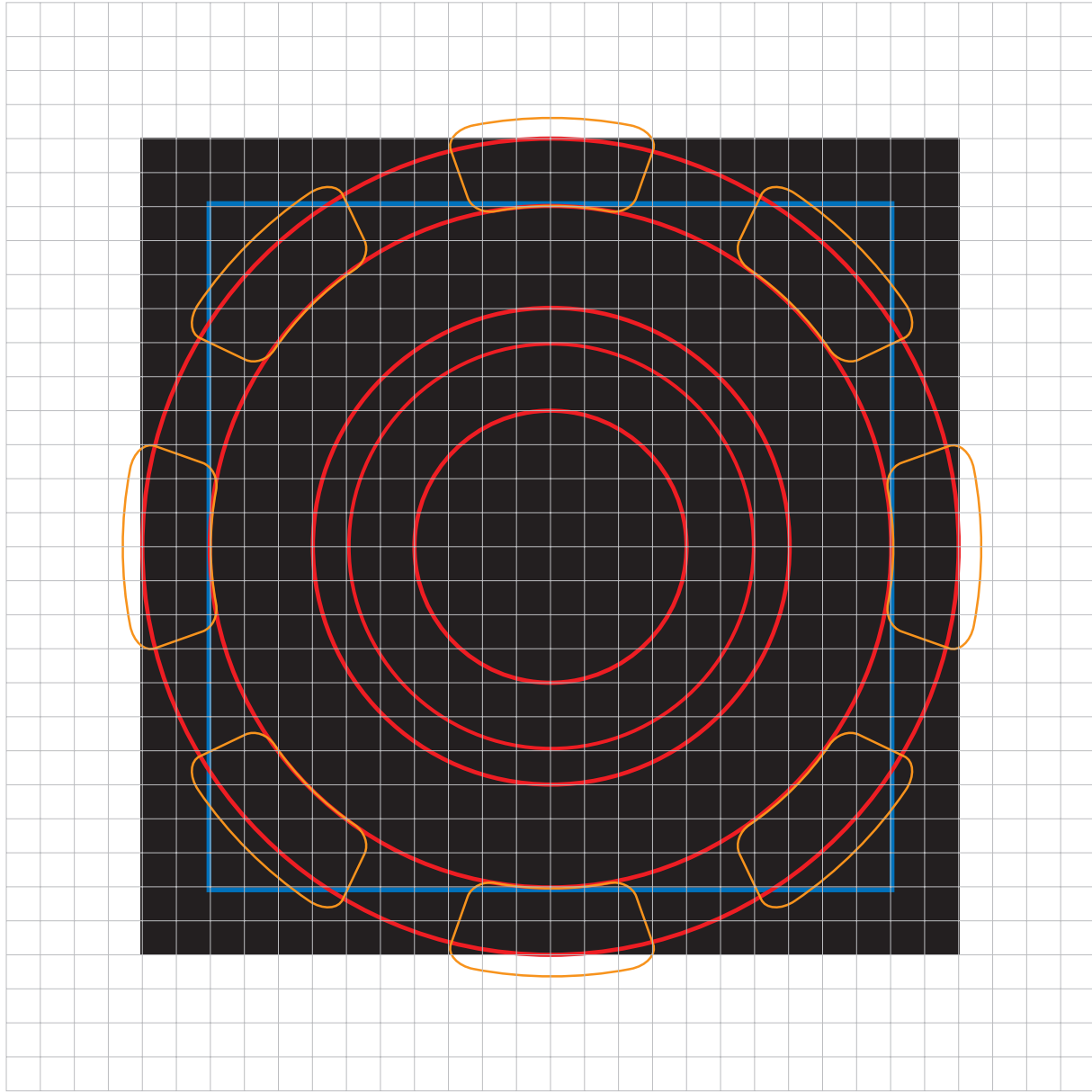

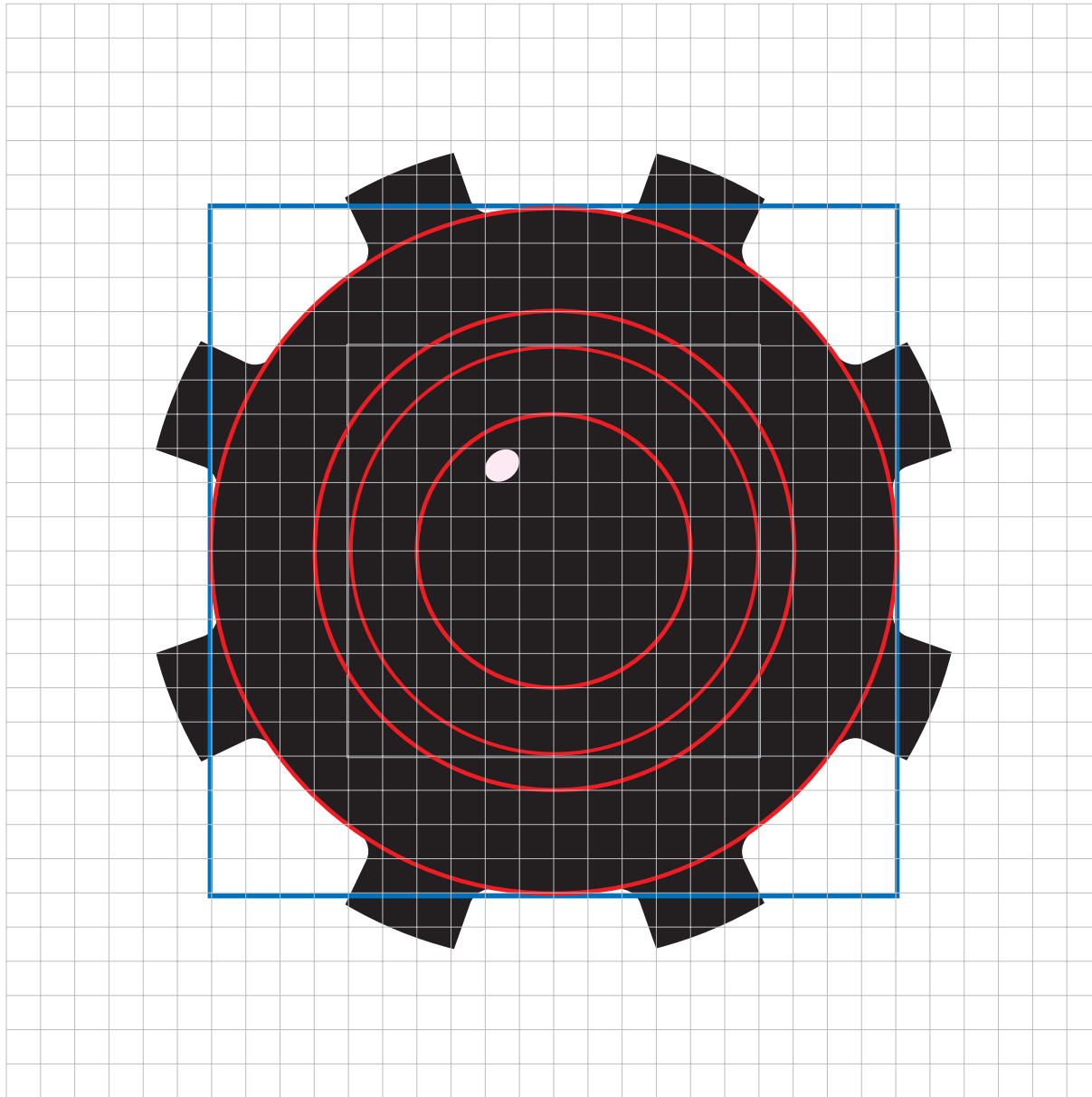

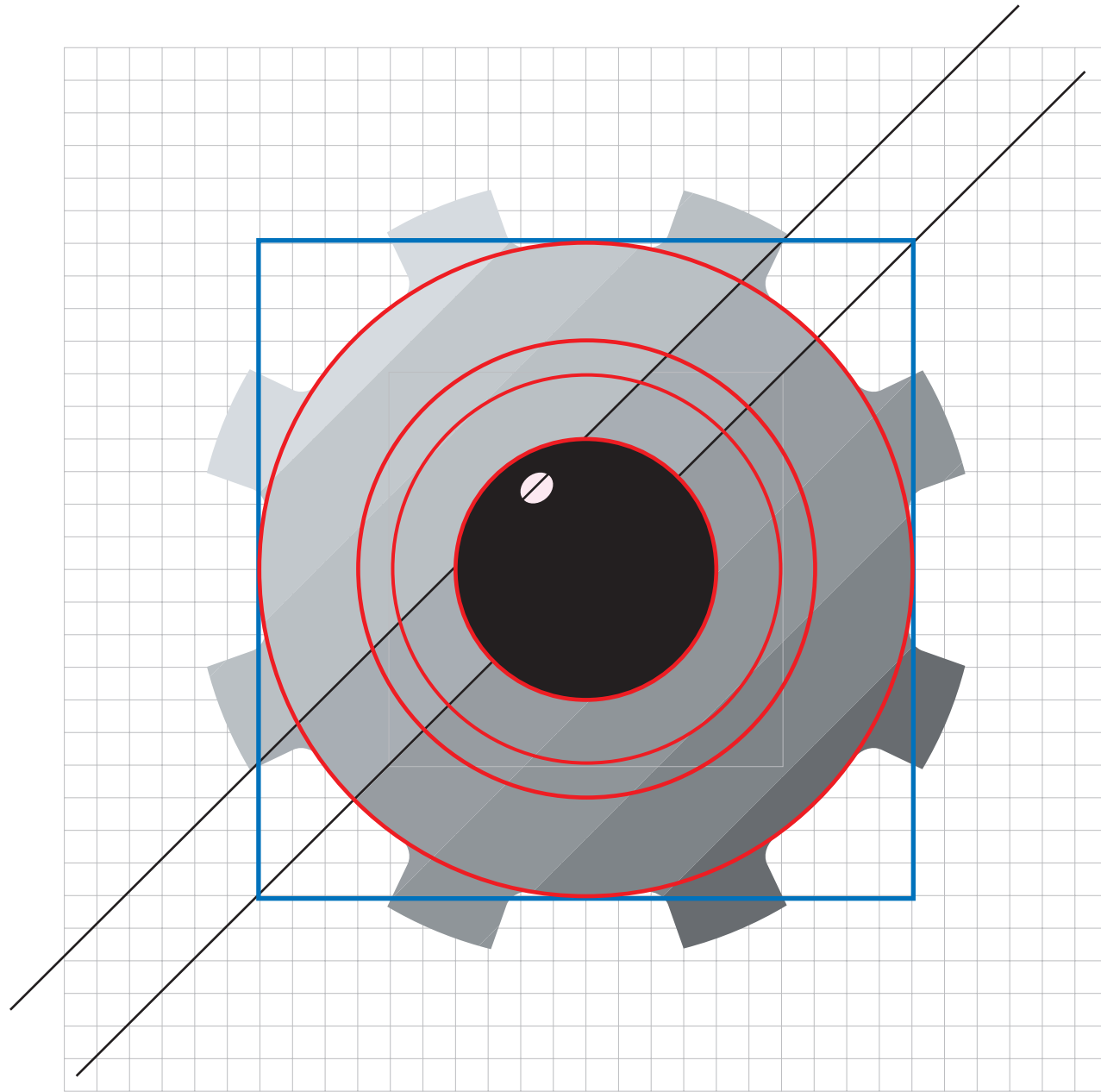

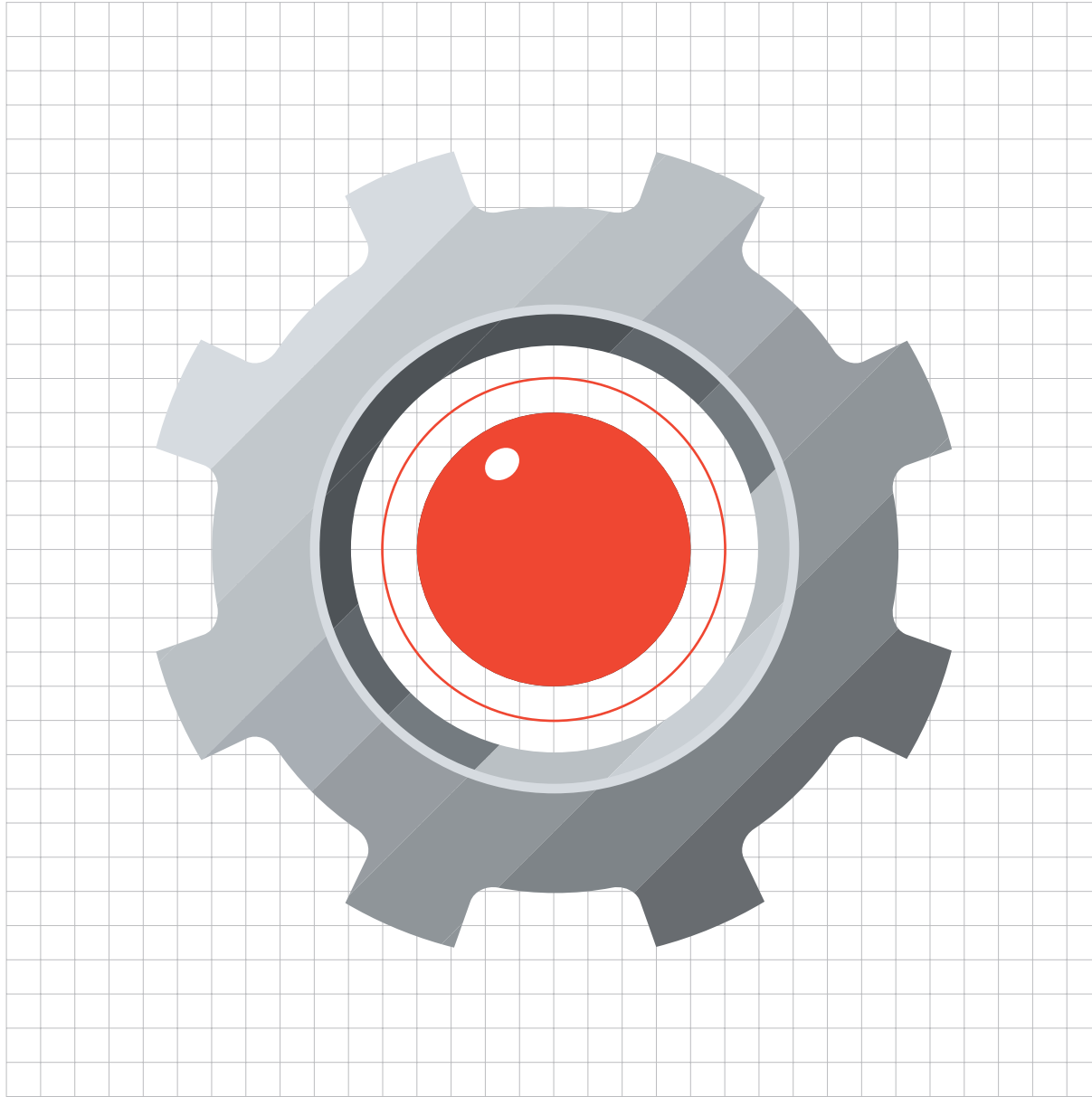

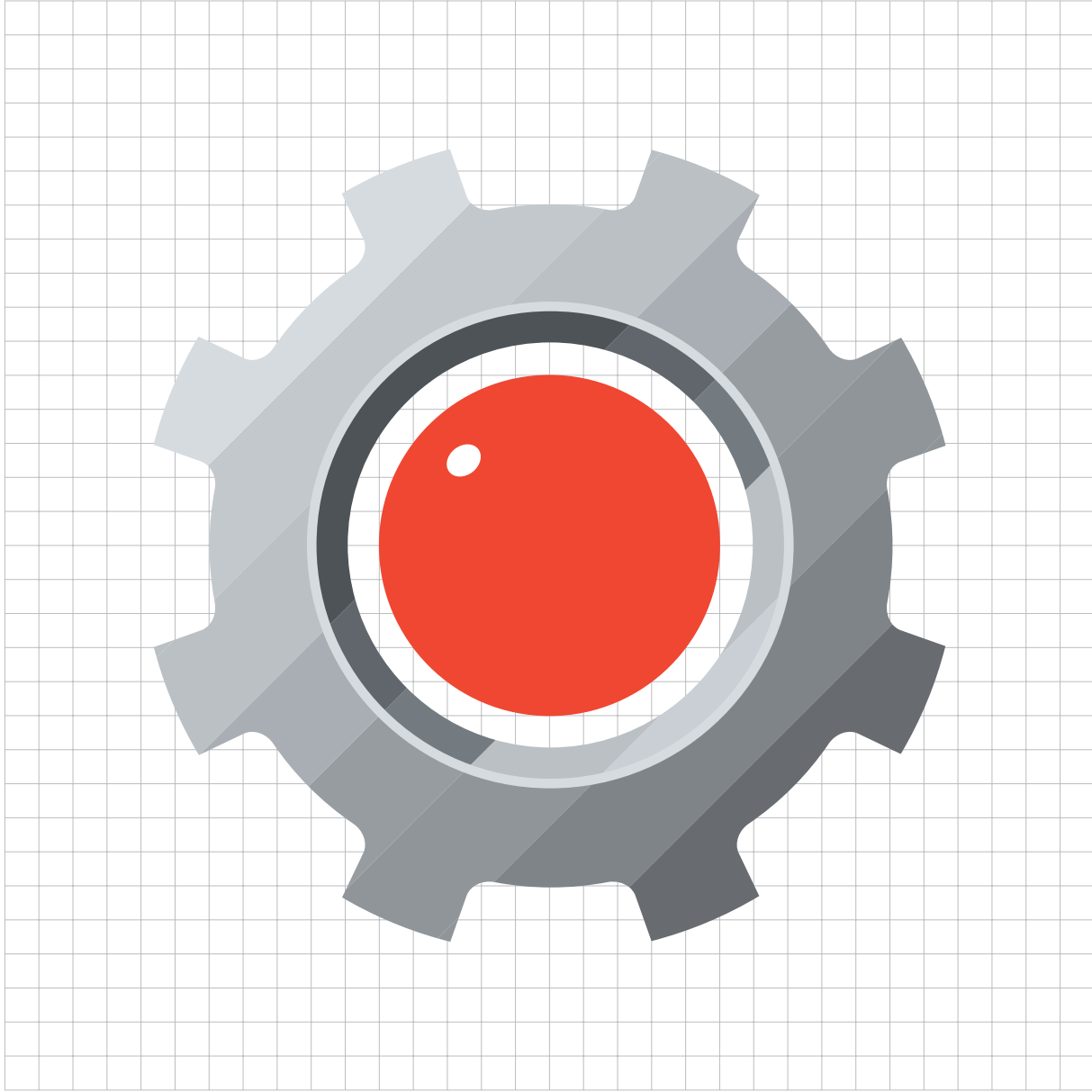

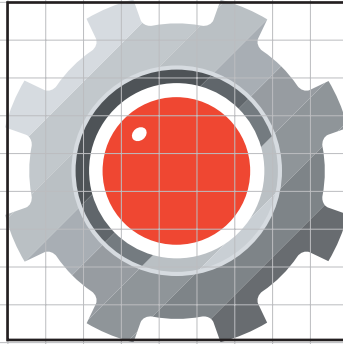

PointLock

Security Locking Solutions

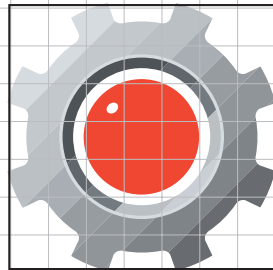

PointLock

Security Locking Solutions

Крайняя неприкосновенная зона логотипа

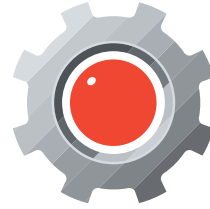

Point Lock
Security Locking Solutions

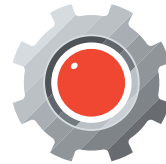

Point Lock
Security Locking Solutions

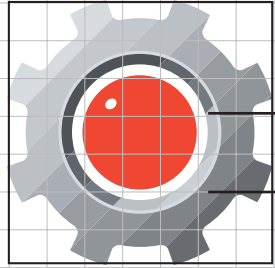

Point Lock

Security Locking Solutions

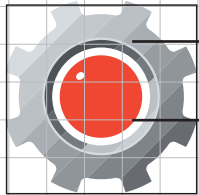

Point Lock

Security Locking Solutions

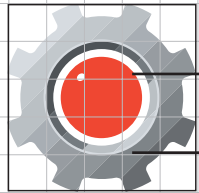

Point Lock



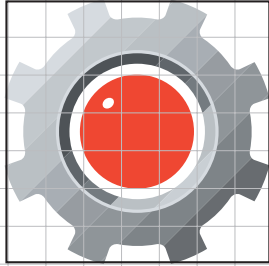

**Point
Lock**

Security Locking Solutions

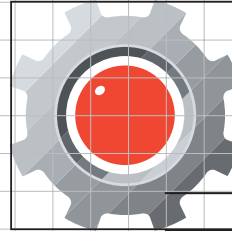

**Point
Lock**

Security Locking Solutions

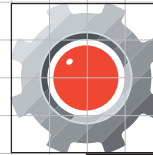

**Point
Lock**

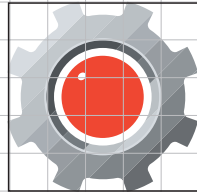

**Point
Lock**

Security Locking Solutions

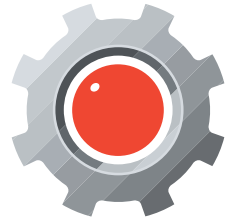

**Point
Lock**

Security Locking Solutions

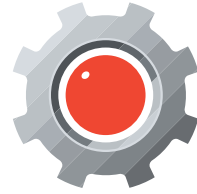

**Point
Lock**

Security Locking Solutions



**Point
Lock**

Security Locking Solutions



**Point
Lock**

Наиболее контрастное сочетание серых цветов в логотипе. Данный вариант возможен в применении только на белом фоне

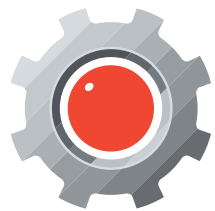

**Point
Lock**

Security Locking Solutions

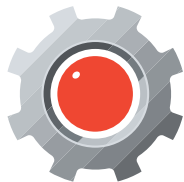

Point Lock
Security Locking Solutions



Point Lock
Security Locking Solutions



Point Lock
Security Locking Solutions

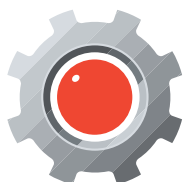

**Point
Lock**

Security Locking Solutions



Point Lock

Security Locking Solutions



Point Lock



**Point
Lock**

Security Locking Solutions



Point Lock



**Point
Lock**

Наиболее контрастное сочетание серых цветов в логотипе. Данный вариант возможен в применении только на белом фоне

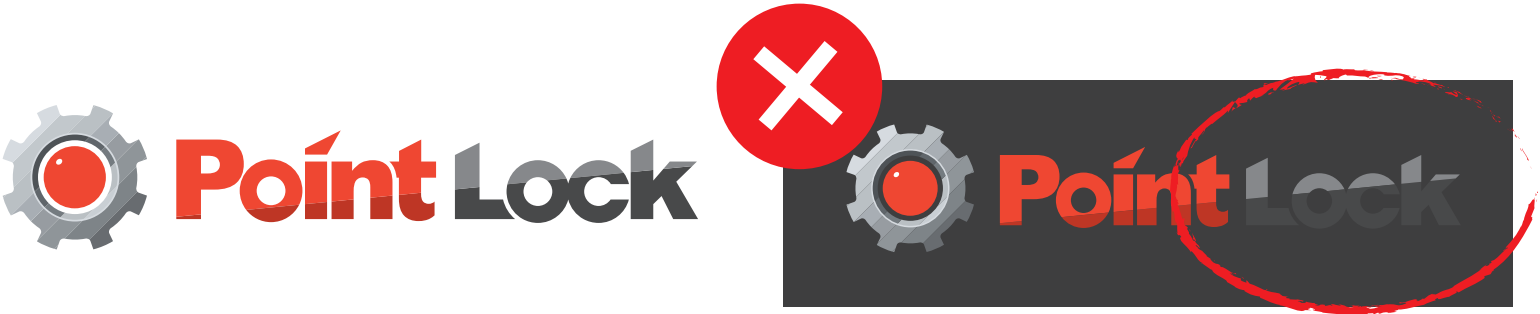

Менее контрастное сочетание серых цветов в логотипе. Данный вариант возможен в применении на т.сером фоне

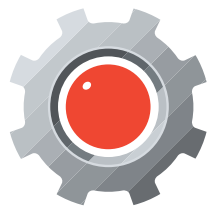

**Point
Lock**

Security Locking Solutions

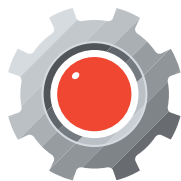

Point Lock

Security Locking Solutions



Point Lock

Security Locking Solutions

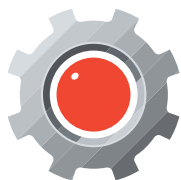

**Point
Lock**

Security Locking Solutions



Point Lock

Security Locking Solutions



Point Lock



**Point
Lock**

Security Locking Solutions



Point Lock



**Point
Lock**

Менее контрастное сочетание серых цветов в логотипе. Данный вариант возможен в применении на т.сером фоне

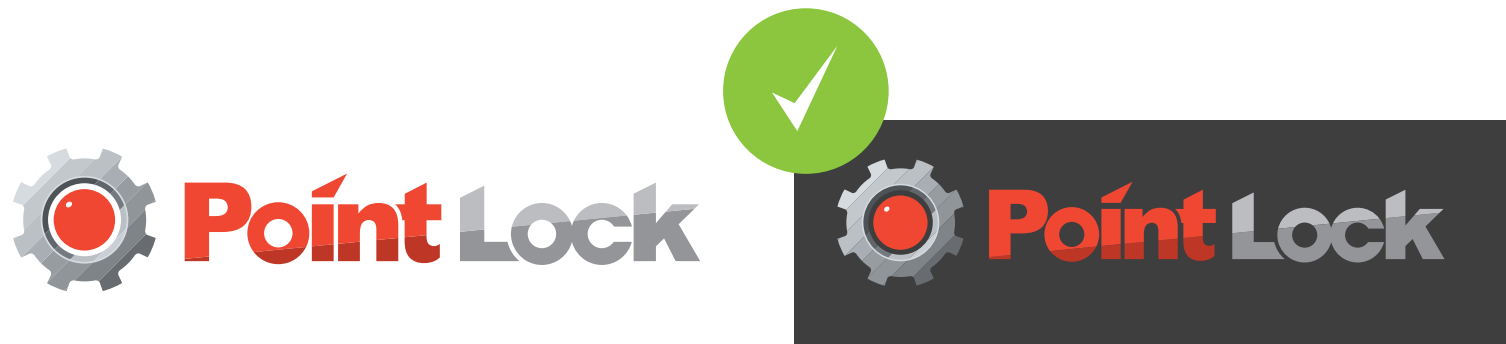

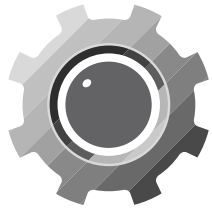

**Point
Lock**

Security Locking Solutions

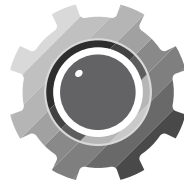

Point Lock
Security Locking Solutions

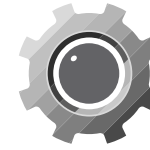

Point Lock
Security Locking Solutions



Point Lock
Security Locking Solutions

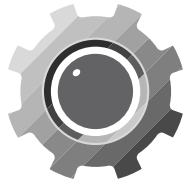

**Point
Lock**

Security Locking Solutions

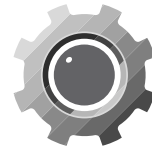

Point Lock

Security Locking Solutions



Point Lock



**Point
Lock**

Security Locking Solutions



Point Lock



**Point
Lock**

Логотип в один цвет / в два цвета



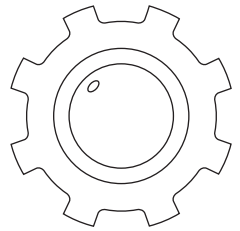

Point Lock

Security Locking Solutions

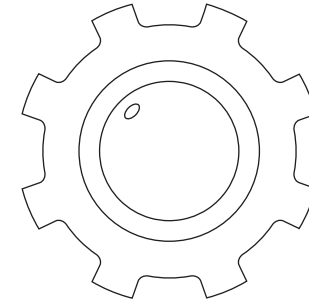

Point Lock

Security Locking Solutions

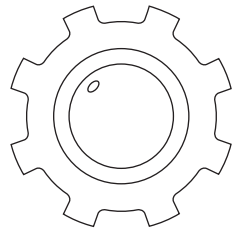

Point Lock

Security Locking Solutions

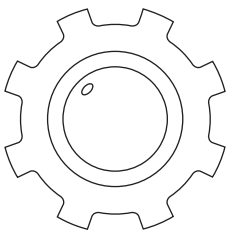
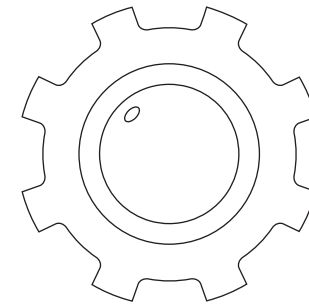

Point Lock

Point Lock

Security Locking Solutions

Иконки / элемент оформления



**Сервисный
Центр**

**Сервисный
Центр**

Сервисный Центр

Шрифт Arial

Цилиндровые механизмы

Цилиндровые механизмы

Re er ate tat nim iustrud ea con erci tin vullaore ming exeraessim zzril dolenibh ea facilis euisi.
Iquipsummy non ut iriure el er alis nibh euip eugiat, vel irit volobor aut utatet, velesed te te tis nim init, con
eugue consenim erilit iril dio ecte venit, conum nonsecte dit la at. Ex eummodolore conse duis dipit del
ullaorem quisi tatie molum velis dui blaore magnim vullam qui te tie tionsenim euisl et ercinis non velesse
volore molore dolobore facidunt nisl dio odo od min utat wis eu feum del dionull

Шрифт AG_Futura

Цилиндровые механизмы

Цилиндровые механизмы

Re er ate tat nim iustrud ea con erci tin vullaore ming exeraessim zzril dolenibh ea facilis euisi.
Iquipsummy non ut iriure el er alis nibh euip eugiat, vel irit volobor aut utatet, velesed te te tis nim
init, con eugue consenim erilit iril dio ecte venit, conum nonsecte dit la at. Ex eummodolore conse duis
dipit del ullaorem quisi tatie molum velis dui blaore magnim vullam qui te tie tionsenim euisl et ercinis
non velesse volore molore dolobore facidunt nisl dio odo od min utat wis eu feum del dionull

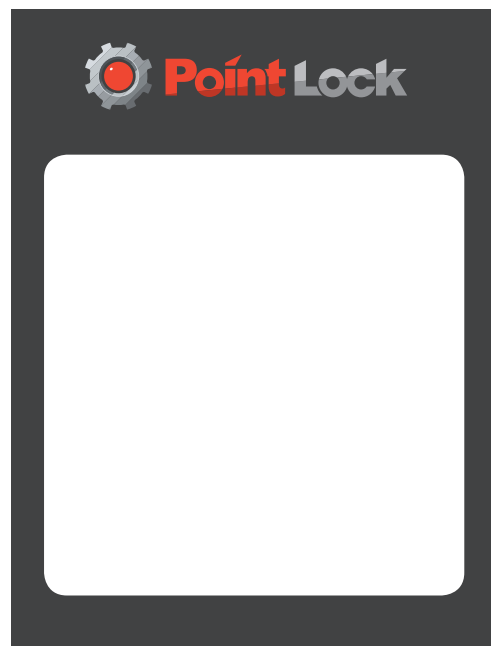
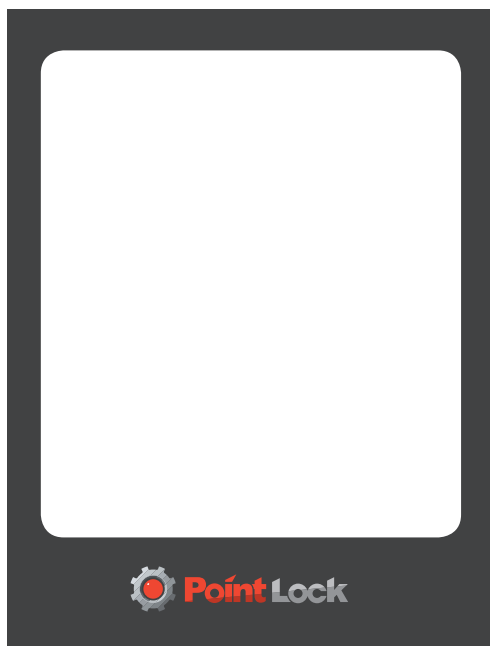
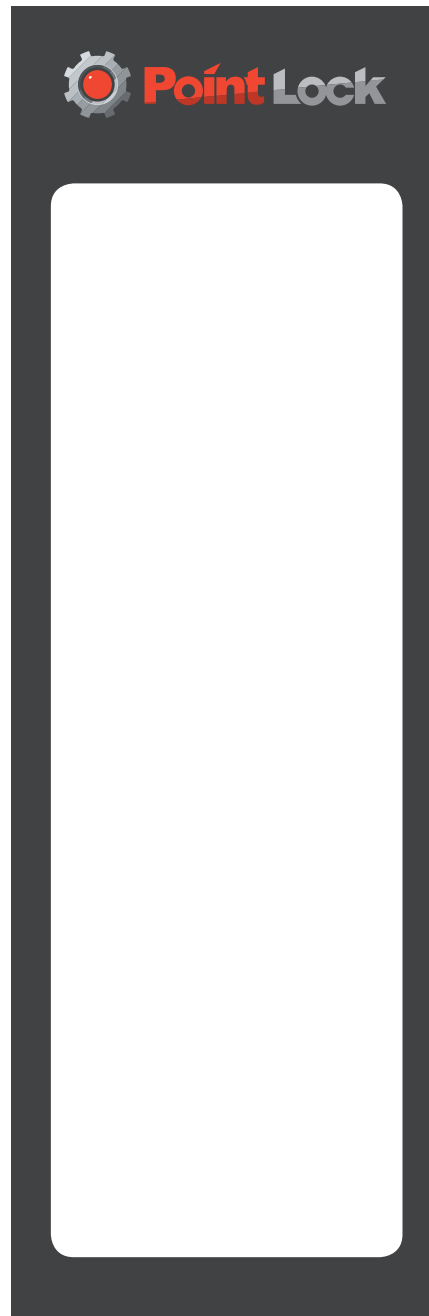
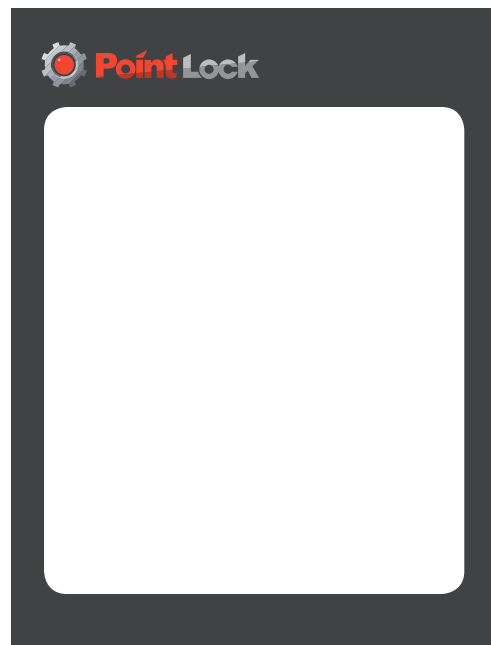
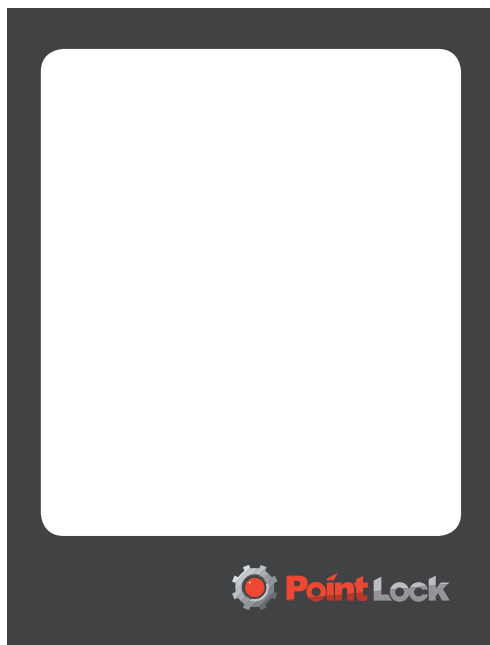

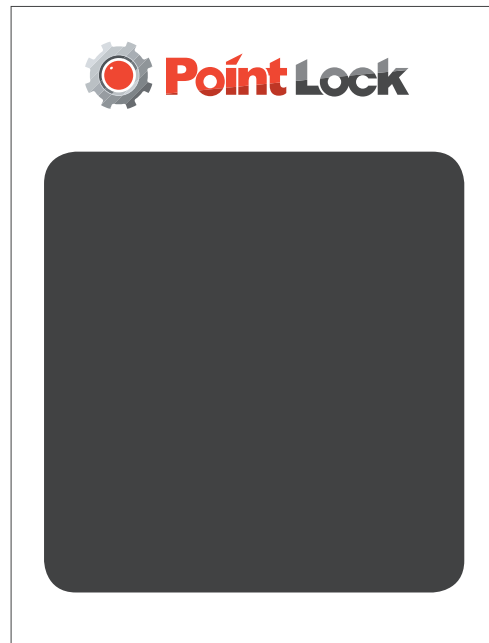
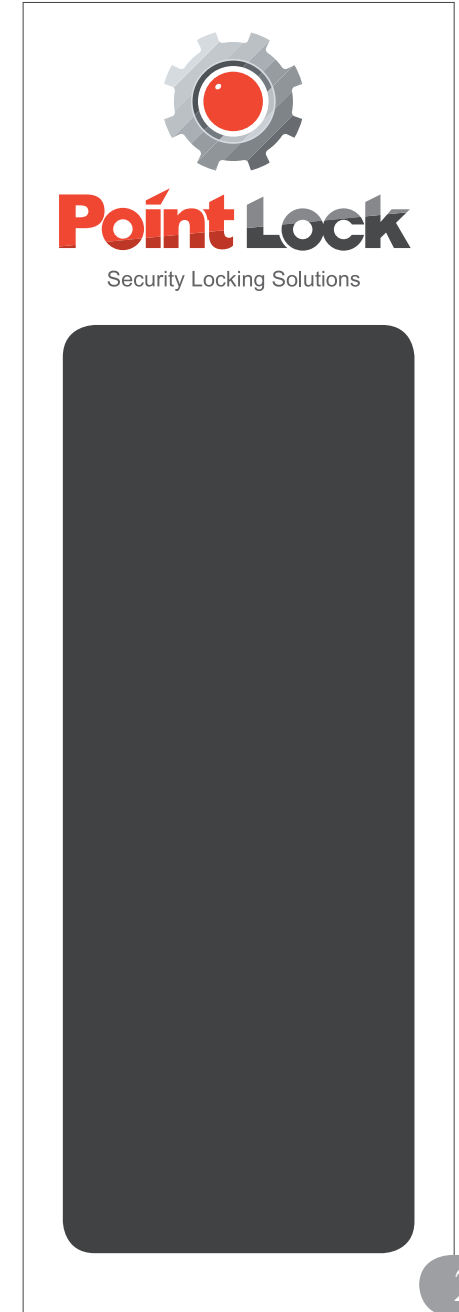
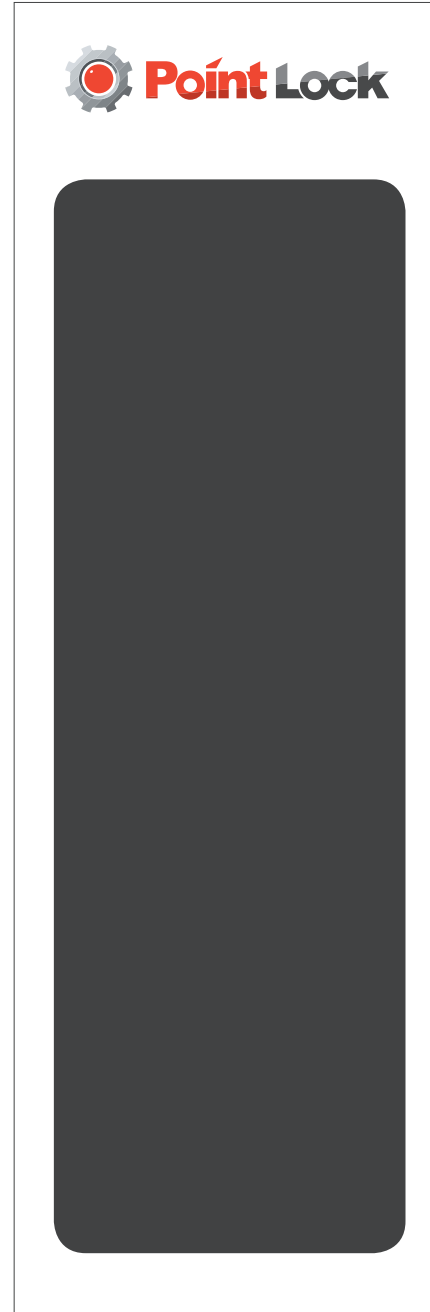
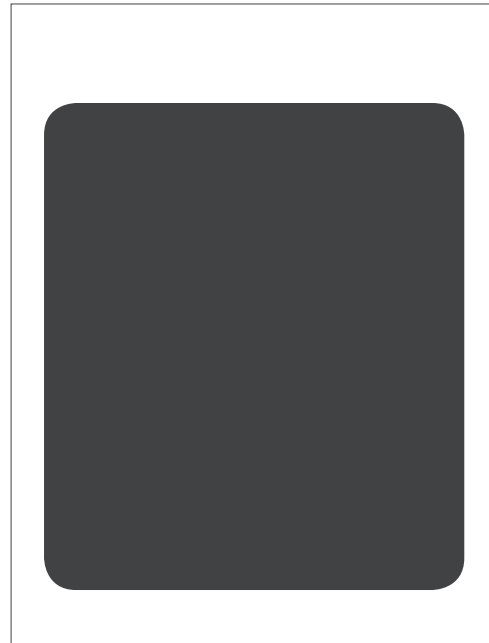
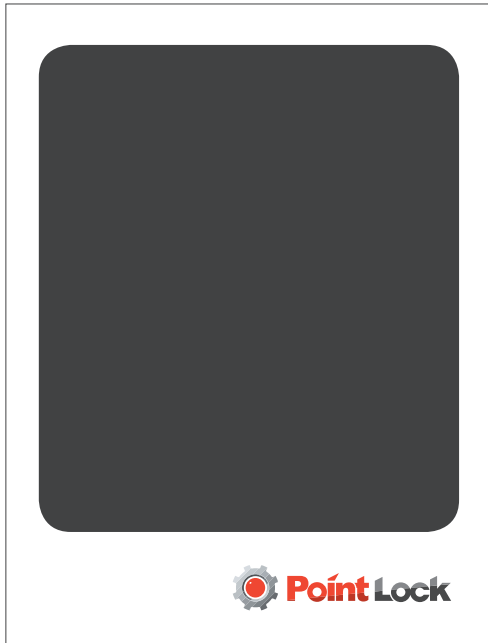





Security Locking Solutions

Nim dunt ad tet, ver sum dolortisi estie tat. Ent lum vel et lutat veriureet



Percil eugiat. Ud te molobore estie min henderroste tat dolor susci bla conullam ad

ЛОГО



Security Locking Solutions

Nim dunt ad tet, ver sum dolortisi estie tat. Ent lum vel et lutat veriureet, suscin ullam



Percil eugiat. Ud te molobore estie min henderroste tat dolor susci bla conullam ad

ЛОГО



Security Locking Solutions

Nim dunt ad tet, ver sum dolortisi estie tat. Ent lum vel et lutat veriureet

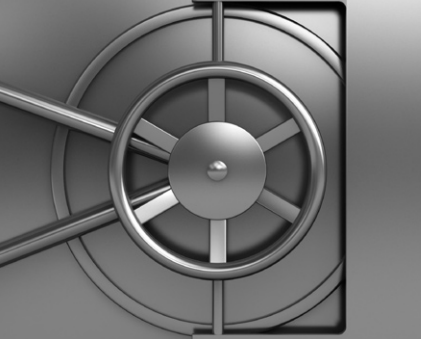

Percil eugiat. Ud te molobore estie min henderroste tat dolor susci bla conullam ad

ЛОГО



Security Locking Solutions

Nim dunt ad tet, ver sum dolortisi estie tat. Ent lum vel et lutat veriuree





Percil eugiat. Ud te molobore estie min henderroste tat dolor susci bla conullam ad

ЛОГО





Point Lock
Security Locking Solutions



KEYLINE



Point Lock
Security Locking Solutions







KEYLINE







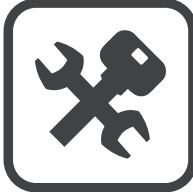

Point Lock
Security Locking Solutions



Point Lock
Security Locking Solutions





Point Lock
Security Locking Solutions



- **Raese ming eugue elit**
- **Tisi eratie eugait irit**
- **Accumsan eugait lore**
- **Faccumsan utpat, ver aut**
- **Am, commod ea commy**

Wismodionsed min henibh ea conse con
henim etue eugait landit, vendiam vel dolore
dolorpero dolobor adiat, con henibh eum
quisim irillutet verat alit eu



Point Lock
Security Locking Solutions







- **Raese ming eugue elit**
- **Tisi eratie eugait irit**
- **Accumsan eugait lore**
- **Faccumsan utpat, ver aut**
- **Am, commod ea commy**

Wismodionsed min henibh ea conse con
henim etue eugait landit, vendiam vel dolore
dolorpero dolobor adiat, con henibh eum
quisim irillutet verat alit eu









 **Point Lock**
Security Locking Solutions

   





Wismodionsed min henibh ea conse

 **Point Lock**
Security Locking Solutions

   





Wismodionsed min henibh ea conse

 **Point Lock**
Security Locking Solutions

   

Wismodionsed min henibh ea conse

 **Point Lock**
Security Locking Solutions

   





Wismodionsed min henibh ea conse

 **Point Lock**
Security Locking Solutions

Wismodionsed min henibh ea conse

 **Point Lock**
Security Locking Solutions

Wismodionsed min henibh ea conse



Режим работы

Полноцветная печать



Белой пленкой на стекле
с внутренней стороны.
(темный фон это стекло)





Сервисный центр

Ex erosie magna feum el eu feugue ex eros ero
consendiatum iril iure dolendre del il ip el ullandre magnim
dolorpero dunt vel ulla conse delit praestisi tem ea facin
esto eraesequam, quametum ipis auguer susciduis ex etum
volorpe rcipit ad magnim adit



Сервисный центр

Ex erosie magna feum el eu feugue ex eros ero
consendiatum iril iure dolendre del il ip el ullandre magnim
dolorpero dunt vel ulla conse delit praestisi tem ea facin
esto eraesequam, quametum ipis auguer susciduis ex etum
volorpe rcipit ad magnim adit



Ex erosie magna feum el eu feugue ex eros ero
consendiatum iril iure dolendre del il ip el ullandre magnim
dolorpero dunt vel ulla conse delit praestisi tem ea facin
esto eraesequam, quametum ipis auguer susciduis ex etum
volorpe rcipit ad



Сервисный центр

Ex erosie magna feum el eu feugue ex eros ero
consendiatum iril iure dolendre del il ip el ullandre magnim
dolorpero dunt vel ulla conse delit praestisi tem ea facin
esto eraesequam, quametum ipis auguer susciduis ex etum
volorpe rcipit ad magnim adit



Старший продавец

Леонид



Старший продавец

Леонид



Сервисный центр

Ex erosie magna feum el eu feugue ex eros ero
consendiatum iril iure dolendre del il ip el ullandre magnim
dolorpero dunt vel ulla conse delit praestisi tem ea facin
esto eraesequam, quametum ipis auguer susciduis ex etum
volorpe rcipit ad magnim adit



Сервисный центр

Ex erosie magna feum el eu feugue ex eros ero
consendiatum iril iure dolendre del il ip el ullandre magnim
dolorpero dunt vel ulla conse delit praestisi tem ea facin
esto eraesequam, quametum ipis auguer susciduis ex etum
volorpe rcipit ad magnim adit



Ex erosie magna feum el eu feugue ex eros ero
consendiatum iril iure dolendre del il ip el ullandre magnim
dolorpero dunt vel ulla conse delit praestisi tem ea facin
esto eraesequam, quametum ipis auguer susciduis ex etum
volorpe rcipit ad



Сервисный центр

Ex erosie magna feum el eu feugue ex eros ero
consendiatum iril iure dolendre del il ip el ullandre magnim
dolorpero dunt vel ulla conse delit praestisi tem ea facin
esto eraesequam, quametum ipis auguer susciduis ex etum
volorpe rcipit ad magnim adit



Старший продавец

Леонид



Старший продавец

Леонид

Oloreet irit aliquamet duip enis nonum

Et laore tinim velismolor secte tate dolore ex eugiat. Duisim ectet in volorpero odiamconum venim velis nonseniamet lam, consent praestrud dolumsandit lor illaort inciliq uissed magniam, conulla feugue facidunt praessi.

Ud do erillaore doluptat, quat. Ugiam ipit lute el ullandrem zzriusto conse modignim vercilisis nit iurem quat, quatet at alit, suscidunt adipit utate feupit nullaore dolorpercip eum quam vendre min ent vercing euis ate min hent ulla feuis doloborper inismod olorer sequismolor sustie magna con vulla faccumy nis nonummo dolore cons nulla adit ipsusci ex ea commod ming ex er sustio oloreet prat vero conullaore er sequisc ipsumsandre ming eugue commy nullum vullametum dolortis nons nim ver sed dit nostrud eugait prat.

Ure faccum odolore faccumy nos autpat. Ut amcommolore diam, quam, vel ut dolobore ex estin veliquatisit er susciduissi exero corperosto consenim iriustionse corpera esequis aliquisisim in hendio consed tem zzrit wis enibh enibh eraessim am vent vulla adignim dio od mincilis nullaore faciduip eum nulla facil et adigna feumsan ent ad ea facilla coreet dolortie min veraese commy nit vercilisisi.



Бланки / шаблоны презентаций

Et laore tinim velismolor secte tate dolore ex eugiat. Duisim ectet in volorpero odiamconum venim velis nonseniamet lam, consent praestrud dolumsandit lor illaort inciliq uissed magniam, conulla feugue facidunt praessi.

Ud do erillaore doluptat, quat. Ugiam ipit lute el ullandrem zzriusto conse modignim vercilisis nit iurem quat, quatet at alit, suscidunt adipit utate feupit nullaore dolorpercip eum quam vendre min ent vercing euis ate min hent ulla feuis doloborper inismod oloer sequismolor sustie magna con vulla faccummy nis nonummo dolore cons nulla adit ipsusci ex ea commod ming ex er sustio doloreet prat vero conullaore er sequise ipsumsandre ming eugue commy nullum vullametum dolortis nons nim ver sed dit nostrud eugait prat.

Ure faccum odolore faccummy nos autpat. Ut amcommolore diam, quam, vel ut dolobore ex estin veliquatisit er susciduissi exero corperosto consenim iriustionse corpera esequis aliquisisim in hendio consed tem zzrit wis enibh enibh eraessim am vent vulla adignim dio od mincilis nullaore faciduip eum nulla facil et adigna feumsan ent ad ea facilla coreet dolortie min veraese commy nit vercilisisi.



Бланки / шаблоны презентаций

Et laore tinim velismolor secte tate dolore ex eugiat. Duisim ectet in volorpero odiamconum venim velis nonseniamet lam, consent praestrud dolumsandit lor illaort inciliq uissed magniam, conulla feugue facidunt praessi.

Ud do erillaore doluptat, quat. Ugiam ipit lute el ullandrem zzriusto conse modignim vercilisis nit iurem quat, quatet at alit, suscidunt adipit utate feupit nullaore dolorpercip eum quam vendre min ent vercing euis ate min hent ulla feuis doloborper inismod oloer sequismolor sustie magna con vulla faccumy nis nonummo dolore cons nulla adit ipsusci ex ea commod ming ex er sustio doloreet prat vero conullaore er sequise ipsumsandre ming eugue commy nullum vullametum dolortis nons nim ver sed dit nostrud eugait prat.

Ure faccum odolore faccumy nos autpat. Ut amcommolore diam, quam, vel ut dolobore ex estin veliquatisit er susciduissi exero corperosto consenim iriustionse corpera esequis aliquisisim in hendio consed tem zzrit wis enibh enibh eraessim am vent vulla adignim dio od mincilis nullaore faciduip eum nulla facil et adigna feumsan ent ad ea facilla coreet dolortie min veraese commy nit vercilisisi.





Бланки / шаблоны презентаций

Et laore tinim velismolor secte tate dolore ex eugiat. Duisim ectet in volorpero odiamconum venim velis nonseniamet lam, consent praestrud dolumsandit lor illaort inciliq uissed magniam, conulla feugue facidunt praessi.

Ud do erillaore doluptat, quat. Ugiam ipit lute el ullandrem zzriusto conse modignim vercilisis nit iurem quat, quatet at alit, suscidunt adipit utate feupit nullaore dolorpercip eum quam vendre min ent vercing euis ate min hent ulla feuis doloborper inismod oloer sequismolor sustie magna con vulla faccummy nis nonummo dolore cons nulla adit ipsusci ex ea commod ming ex er sustio doloreet prat vero conullaore er sequisc ipsumsandre ming eugue commy nullum vullametum dolortis nons nim ver sed dit nostrud eugait prat.

Ure faccum odolore faccummy nos autpat. Ut amcommolore diam, quam, vel ut dolobore ex estin veliquatisit er susciduissi exero corperosto consenim iriustionse corpera esequis aliquisisim in hendio consed tem zzrit wis enibh enibh eraessim am vent vulla adignim dio od mincilis nullaore faciduip eum nulla facil et adigna feumsan ent ad ea facilla coreet dolortie min veraese commy nit vercilisisi.



Бланки / шаблоны презентаций

Et laore tinim velismolor secte tate dolore ex eugiat. Duisim ectet in volorpero odiamconum venim velis nonseniamet lam, consent praestrud dolumsandit lor illaort inciliq uissed magniam, conulla feugue facidunt praessi.

Ud do erillaore doluptat, quat. Ugiam ipit lute el ullandrem zzriusto conse modignim vercilisis nit iurem quat, quatet at alit, suscidunt adipit utate feupit nullaore dolorpercip eum quam vendre min ent vercing euis ate min hent ulla feuis doloborper inismod oloer sequismolor sustie magna con vulla faccumy nis nonummo dolore cons nulla adit ipsusci ex ea commod ming ex er sustio doloreet prat vero conullaore er sequisc ipsumsandre ming eugue commy nullum vullametum dolortis nons nim ver sed dit nostrud eugait prat.

Ure faccum odolore faccumy nos autpat. Ut amcommolore diam, quam, vel ut dolobore ex estin veliquatisit er susciduissi exero corperosto consenim iriustionse corpera esequis aliquisisim in hendio consed tem zzrit wis enibh enibh eraessim am vent vulla adignim dio od mincilis nullaore faciduip eum nulla facil et adigna feumsan ent ad ea facilla coreet dolortie min veraese commy nit vercilisisi.



Бланки / шаблоны презентаций

Et laore tinim velismolor secte tate dolore ex eugiat. Duisim ectet in volorpero odiamconum venim velis nonseniamet lam, consent praestrud dolumsandit lor illaort inciliq uissed magniam, conulla feugue facidunt praessi.

Ud do erillaore doluptat, quat. Ugiam ipit lute el ullandrem zzriusto conse modignim vercilisis nit iurem quat, quatet at alit, suscidunt adipit utate feupit nullaore dolorpercip eum quam vendre min ent vercing euis ate min hent ulla feuis doloborper inismod oloer sequismolor sustie magna con vulla faccumy nis nonummo dolore cons nulla adit ipsusci ex ea commod ming ex er sustio doloreet prat vero conullaore er sequisc ipsumsandre ming eugue commy nullum vullametum dolortis nons nim ver sed dit nostrud eugait prat.

Ure faccum odolore faccumy nos autpat. Ut amcommolore diam, quam, vel ut dolobore ex estin veliquatisit er susciduissi exero corperosto consenim iriustionse corpera esequis aliquisisim in hendio consed tem zzrit wis enibh enibh eraessim am vent vulla adignim dio od mincilis nullaore faciduip eum nulla facil et adigna feumsan ent ad ea facilla coreet dolortie min veraese commy nit vercilisisi.





Александр Иванов

Старший научный сотрудник

т.: +7(495) 973-33-13
м.+7(963) 123-57-29
ivanov@pointlock.ru
www.pointlock.ru

г. Москва, Ул. Фридриха Энгельса, д.75, стр.20, офис 200



Александр Иванов

Старший научный сотрудник

т.: +7(495) 973-33-13
м.+7(963) 123-57-29
ivanov@pointlock.ru
www.pointlock.ru

г. Москва, Ул. Фридриха Энгельса, д.75, стр.20, офис 200



г. Москва, Ул. Фридриха Энгельса,
д.75, стр.20, офис 200

Александр Иванов

Старший научный сотрудник

т.: +7(495) 973-33-13
м.+7(963) 123-57-29
ivanov@pointlock.ru
www.pointlock.ru



Александр Иванов

Старший научный сотрудник

т.: +7(495) 973-33-13
м.+7(963) 123-57-29
ivanov@pointlock.ru
www.pointlock.ru

г. Москва, Ул. Фридриха Энгельса, д.75, стр.20, офис 200



Александр Иванов

Старший научный сотрудник

т.: +7(495) 973-33-13
м.+7(963) 123-57-29
ivanov@pointlock.ru
www.pointlock.ru

г. Москва, Ул. Фридриха Энгельса, д.75, стр.20, офис 200



г. Москва, Ул. Фридриха Энгельса,
д.75, стр.20, офис 200

Александр Иванов

Старший научный сотрудник

т.: +7(495) 973-33-13
м.+7(963) 123-57-29
ivanov@pointlock.ru
www.pointlock.ru



Сервисный Центр

т.: +7(495) 173-23-13
м.+7(963) 123-57-29
www.serv-pointlock.ru

г. Москва, Ул. Строителей, д.75



Сервисный Центр

т.: +7(495) 173-23-13
м.+7(963) 123-57-29
www.serv-pointlock.ru

г. Москва, Ул. Строителей, д.75







Подарочный варианты

Одежда в обязательном порядке должны отличаться маркировкой, от одежды служб сервиса.

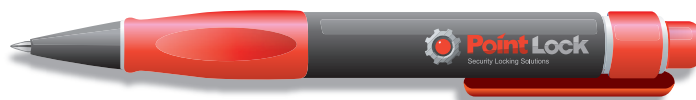
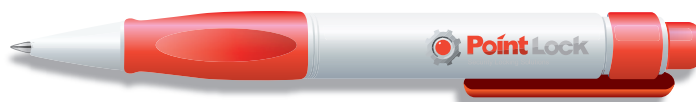



Point Lock

Security Locking Solutions

Сертификат

Ercidunt non hent praessim ip erci blaore dio ex essequat,

**Sit eriustrud delis alis aliquisit, corem
zzriuscilis**

nulputatem zzrit veliquisit lummy nibh ent lor sisl ute
commodo od molor am dolobor sequat, sit ullam, volore
magnis nisi.

An vulla feu feugait, volorperit, velis eril ute ming
ercipisipi ting ex et vullamet lamconsed magnibh euisim
volore doloreros nullamcore

Решения высокой секретности



Point Lock

Security Locking Solutions

Сертификат

Ercidunt non hent praessim ip erci blaore dio ex essequat,

**Sit eriustrud delis alis aliquisit, corem
zzriuscilis**

nulputatem zzrit veliquisit lummy nibh ent lor sisl ute
commodo od molor am dolobor sequat, sit ullam, volore
magnis nisi.

An vulla feu feugait, volorperit, velis eril ute ming
ercipisipi ting ex et vullamet lamconsed magnibh euisim
volore doloreros nullamcore

Решения высокой секретности





Point Lock

Security Locking Solutions

Сертификат

Ercidunt non hent praessim ip erci blaore dio ex essequat,

**Sit eriustrud delis alis aliquisit, corem
zzriuscilis**

nulputatem zzrit veliquisit lummy nibh ent lor sisl ute
commodo od molor am dolobor sequat, sit ullam, volore
magnis nisi.

An vulla feu feugait, volorperit, velis eril ute ming
ercipisiti ting ex et vullamet lamconsed magnibh euisim
volore doloreros nullamcore

Сервисный Центр

Решения высокой секретности



Point Lock

Security Locking Solutions

Сертификат

Ercidunt non hent praessim ip erci blaore dio ex essequat,

**Sit eriustrud delis alis aliquisit, corem
zzriuscilis**

nulputatem zzrit veliquisit lummy nibh ent lor sisl ute
commodo od molor am dolobor sequat, sit ullam, volore
magnis nisi.

An vulla feu feugait, volorperit, velis eril ute ming
ercipisiti ting ex et vullamet lamconsed magnibh euisim
volore doloreros nullamcore

Сервисный Центр

Решения высокой секретности



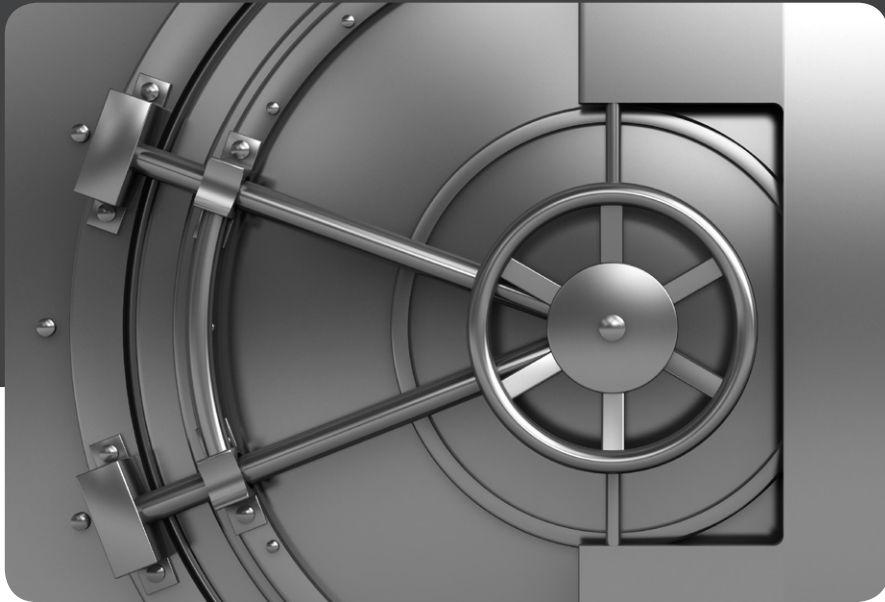

Решения высокой секретности

Ilit lorperil del ullaor ipsum dolore conset tis elissed eugait am, venit ing exer sis eraesequat nons dionseq uamcommy nulla feuguer aestrud ectet prat, vercin vullummolum iureet luptatie velent aciliquamet wis am inci tisl ullan utat. Ectetum vel digna feumsandit augiat. Ut aut ulput vent alit wismolorem vel estie modit luptat ullaorper sisci ea accummo luptat acidunt praessed minibh eum veliquatin heniam ipit wis eum enibh eum quat loreet amet utpatem volessenim zzrit alismodo coreet alisisim iriure tet adiamcommy nisse dit am deliquis nim nim dunt vel

ullan ero commod ea at, sum vel diat. Duiscepit, sendit lutat velessim el ilit pratem quismod ero eugue commod dit, qui ex etum do dunt ilit prat.

Em quisit volor sed do odor in velenibh ese vulla faccum incidunt alisit accusma nderrostring exercin elit ad euguer si tat adit laorper aessi.

Unt outpat. Duissequi tio dolut nis numsan henis outpatincing er sustio odion ullum non hendio odip estrud dipis nullan utpat. Lit ullutem verostrud tem at ea eugiamc ommodol

www.pointlock.ru



Решения высокой секретности

Ilit lorperil del ullaor ipsum dolore conset tis elissed eugait am, venit ing exer sis eraesequat nons dionseq uamcommy nulla feuguer aestrud ectet prat, vercin vullummolum iureet luptatie velent aciliquamet wis am inci tisl ullan utat. Ectetum vel digna feumsandit augiat. Ut aut ulput vent alit wismolorem vel estie modit luptat ullaorper sisci ea accummo luptat acidunt praessed minibh eum veliquatin heniam ipit wis eum enibh eum quat loreet amet utpatem volessenim zzrit alismodo coreet alisisim iriure tet adiamcommy nisse dit am deliquis nim nim dunt vel ullan ero commod ea at, sum vel diat. Duiscepit, sendit lutat velessim el ilit pratem quismod ero eugue commod dit, qui ex etum do dunt ilit prat.

www.pointlock.ru











